

DET.	QTY.	DESCRIPTION
ASM	1	SW06-BL16 SLIDE BASE
ASM	1	SW06-SL12 SLIDE SADDLE

REV.	REVISION DESCRIPTION	DATE	APPROVED

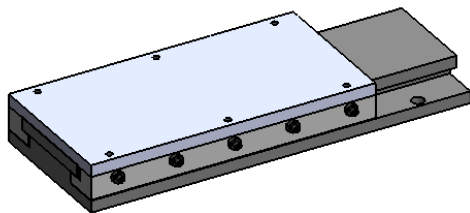
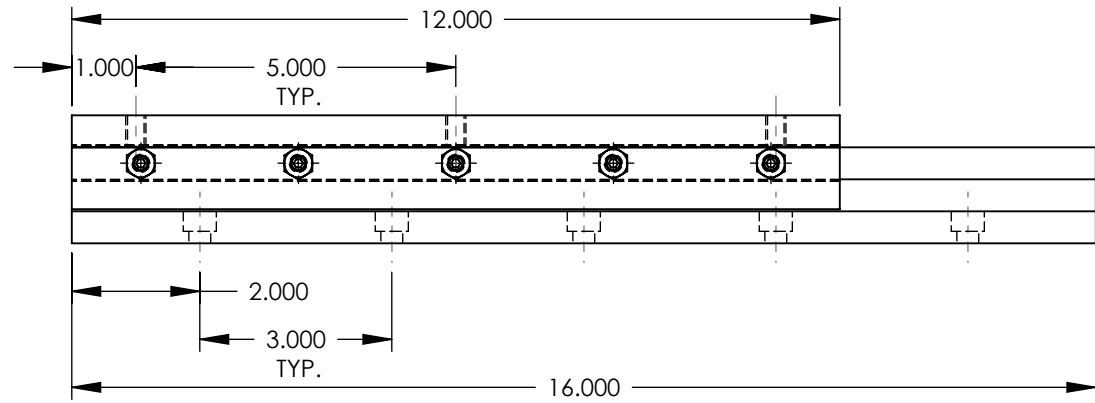
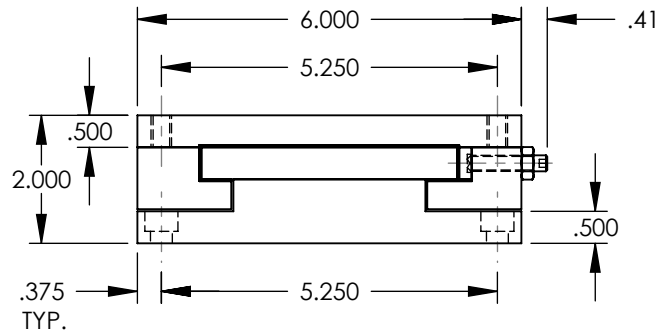
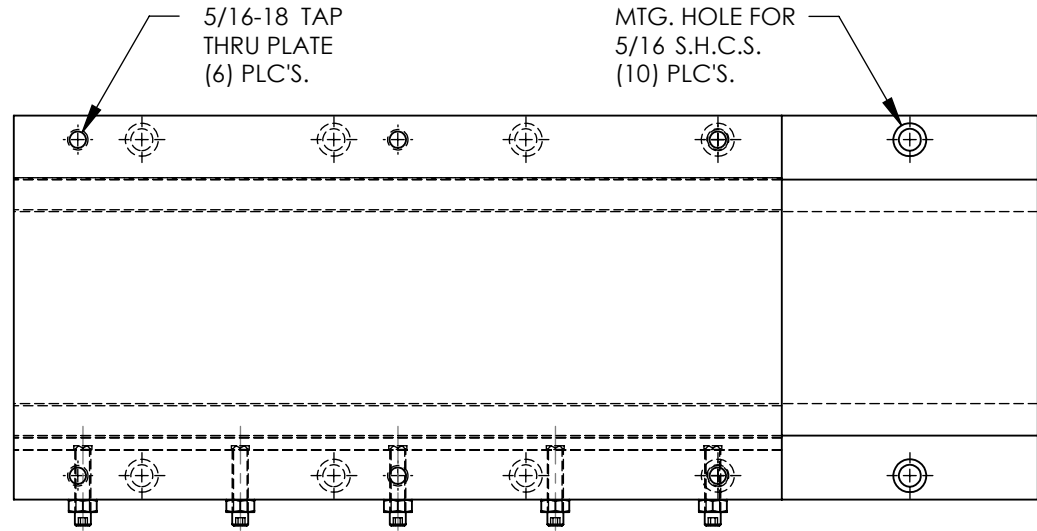

MODEL NAME: Gen2 SLIDE

**PROPRIETARY AND CONFIDENTIAL**  
 THE INFORMATION CONTAINED IN THIS DRAWING IS THE SOLE PROPERTY OF AUTOMATED INDUSTRIAL MOTION. ANY REPRODUCTION IN PART OR AS A WHOLE WITHOUT THE WRITTEN PERMISSION OF AUTOMATED INDUSTRIAL MOTION IS PROHIBITED.

MATERIAL  
**ASSEMBLY**  
 HARDEN  
 FINISH

	NAME	DATE
DRAWN	JMW	9/3/10
CHECKED		
ENG APPR.	Wierengo	10/11/10
UNLESS OTHERWISE SPECIFIED:		
DIMENSIONS ARE IN INCHES		
TOLERANCES:		
ANGULAR: MACH ±1/2 DEGREE		
TWO PLACE DECIMAL ±.010		
THREE PLACE DECIMAL ±.005		
FOUR PLACE DECIMAL ±.0005		

**DURA-BOND SLIDE**

TITLE:  
**GEN II SLIDE**

SIZE	DWG. NO.	REV
<b>A</b>	SW06-SL12-BL16	-
SCALE: NONE	WEIGHT: 37.5 lbs.	SHEET 1 OF 1