

DET.	QTY.	DESCRIPTION
ASM	1	SW02-BL04 SLIDE BASE
ASM	1	SW02-SL03 SLIDE SADDLE WITH LOCK HANDLE
\$02	1	ADJUSTABLE HANDLE, KHB-52, #10-32 THREAD x .59 LG.

REV.	REVISION DESCRIPTION	DATE	APPROVED

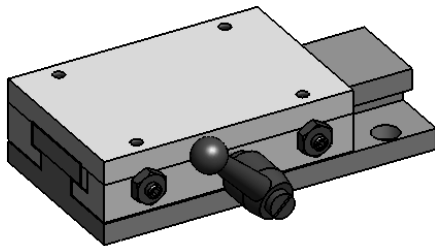
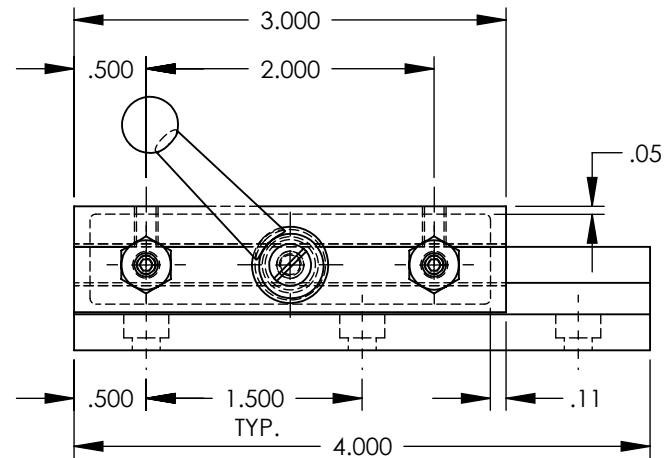
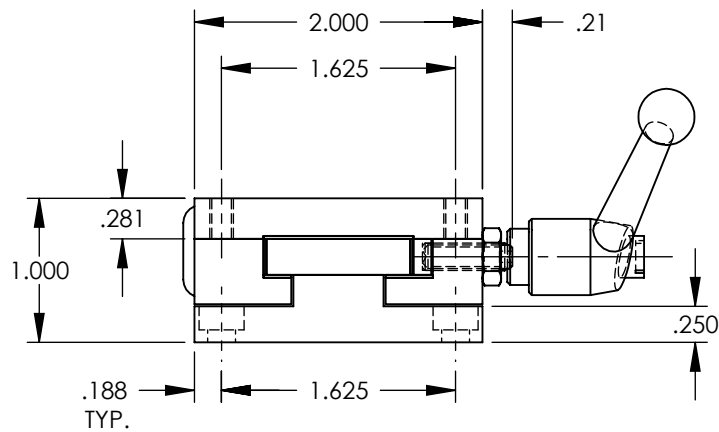
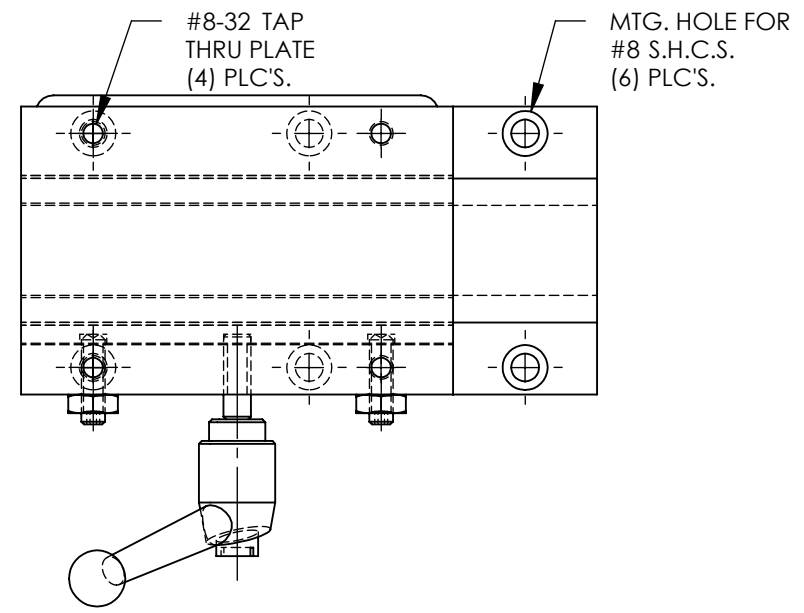

MODEL NAME: Gen2 SLIDE

PROPRIETARY AND CONFIDENTIAL THE INFORMATION CONTAINED IN THIS DRAWING IS THE SOLE PROPERTY OF AUTOMATED INDUSTRIAL MOTION. ANY REPRODUCTION IN PART OR AS A WHOLE WITHOUT THE WRITTEN PERMISSION OF AUTOMATED INDUSTRIAL MOTION IS PROHIBITED.	NAME	DATE	DURA-BOND SLIDE TITLE:		
	DRAWN	JMW			06/08/11
	CHECKED			GEN II SLIDE	
	ENG APPR.	Wierengo	06/15/11		
MATERIAL	UNLESS OTHERWISE SPECIFIED:		SIZE	DWG. NO.	REV
ASSEMBLY	DIMENSIONS ARE IN INCHES		A	SW02-SL03-BL04-LH	-
HARDEN	TOLERANCES:				
FINISH	ANGULAR: MACH ±1/2 DEGREE				
	TWO PLACE DECIMAL ±.010				
		THREE PLACE DECIMAL ±.005	SCALE: NONE	WEIGHT: 2.0 lbs.	SHEET 1 OF 1
		FOUR PLACE DECIMAL ±.0005			